

Powered by



# GPL 1272 ▶ 12V 7.2Ah

GPL 1272 is a general purpose battery up to 8 years in standby service or more than 260 cycles at 100% discharge in cycle service . As with all CSB batteries, all are rechargeable , highly efficient , leak proof and maintenance free.



## ► Specification

<b>Cells Per Unit</b>	6
<b>Voltage Per Unit</b>	12
<b>Capacity</b>	7.2Ah @ 20hr-rate to 1.75V per cell @25°C (77°F)
<b>Weight</b>	Approx. 2.6 kg(5.73 lbs)
<b>Maximum Discharge Current</b>	100A/130A(5sec)
<b>Internal Resistance</b>	Approx. 21 mΩ
<b>Operating Temperature Range</b>	Discharge: -15°C~50°C ( 5°F~122°F) Charge: -15°C~40°C ( 5°F~104°F) Storage: -15°C~40°C ( 5°F~104°F)
<b>Nominal Operating Temperature Range</b>	25°C±3°C ( 77°F±5°F)
<b>Float Charging Voltage</b>	13.5 to 13.8 VDC/unit Average at 25°C (77°F)
<b>Recommended Maximum Charging Current Limit</b>	2.16A
<b>Equalization and Cycle Service</b>	14.4 to 15.0 VDC/unit Average at 25°C (77°F)
<b>Self Discharge</b>	CSB Batteries can be stored for more than 6 months at 25°C (77°F). Please charge batteries before using . For higher temperatures the time interval will be shorter.
<b>Terminal</b>	F1/F2-Faston Tab187/250
<b>Container Material</b>	ABS(UL 94-HB) & Flammability resistance of (UL 94-V0) can be available upon request.



CSB-manufactured **VRLA** (Absorbent **G**lass **M**at type) batteries are UL-recognized components under UL1989.

CSB is also certified by ISO 9001 and ISO 14001.

► Dimensions :	Overall Height (H)	Container height (h)	Length (L)	Width (W)
Unit: mm (inch)	98.6±1.5 (3.88±0.06)	94.3±1 (3.71±0.04)	151±2 (5.94±0.08)	64.8±1 (2.55±0.04)

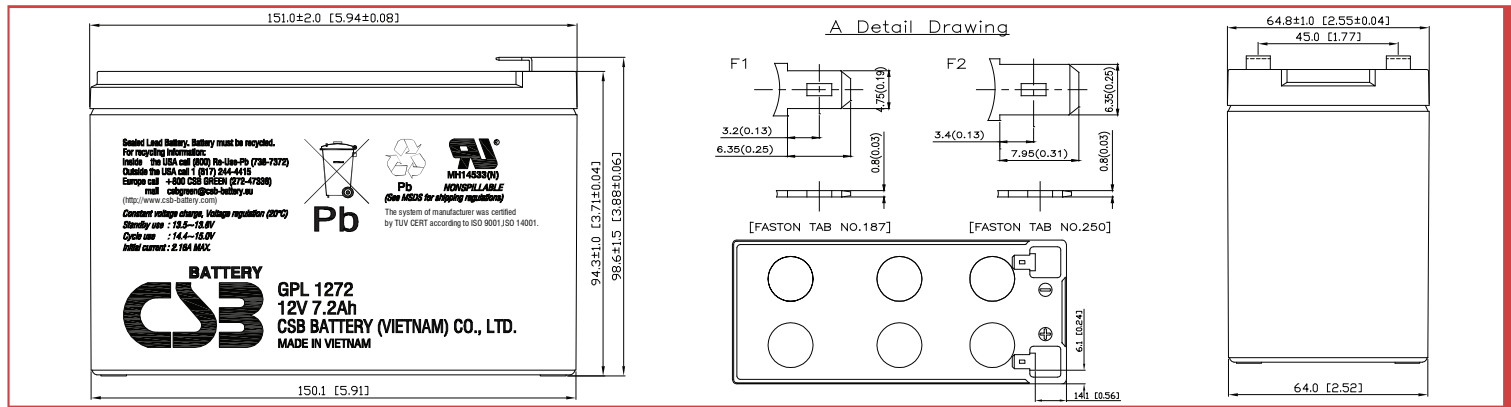

## Constant Current Discharge Characteristics Unit:A (25°,77°F)

F.V/Time	5MIN	10MIN	15MIN	30MIN	60MIN	90MIN	2HR	3HR	5HR	8HR	10HR	20HR
1.60V	24.1	19.2	15.6	9.05	4.87	3.43	2.67	1.93	1.29	0.90	0.73	0.37
1.67V	23.1	18.3	14.9	8.80	4.72	3.33	2.60	1.89	1.28	0.88	0.72	0.36
1.70V	22.6	17.8	14.5	8.68	4.65	3.28	2.56	1.87	1.27	0.87	0.72	0.36
1.75V	21.8	17.0	13.9	8.45	4.52	3.20	2.50	1.82	1.23	0.86	0.70	0.36
1.80V	20.8	16.2	13.2	8.19	4.39	3.13	2.46	1.77	1.20	0.84	0.69	0.35
1.85V	19.6	15.3	12.5	7.87	4.27	3.04	2.39	1.74	1.16	0.82	0.67	0.34

## Constant Power Discharge Characteristics Unit:W (25°C,77°F)

F.V/Time	5MIN	10MIN	15MIN	30MIN	60MIN	90MIN	2HR	3HR	5HR	8HR	10HR	20HR
1.60V	258	210	173	103	54.0	38.1	29.8	22.0	15.3	10.5	8.78	4.46
1.67V	251	202	166	101	53.3	37.4	29.1	21.8	15.0	10.4	8.64	4.40
1.70V	247	199	162	99.3	52.9	37.1	28.8	21.6	14.9	10.2	8.57	4.36
1.75V	240	192	156	97.4	52.3	36.5	28.2	21.2	14.5	10.1	8.45	4.28
1.80V	231	185	151	95.0	51.5	35.8	27.7	20.8	14.1	10.0	8.29	4.20
1.85V	222	177	146	92.2	50.6	35.2	27.2	20.4	13.8	9.72	8.14	4.12

Ratings presented herein are subject to revision without notice. Please refer to [www.csb-battery.com](http://www.csb-battery.com) to confirm the latest version.

### Trickle (or Float) Service Life

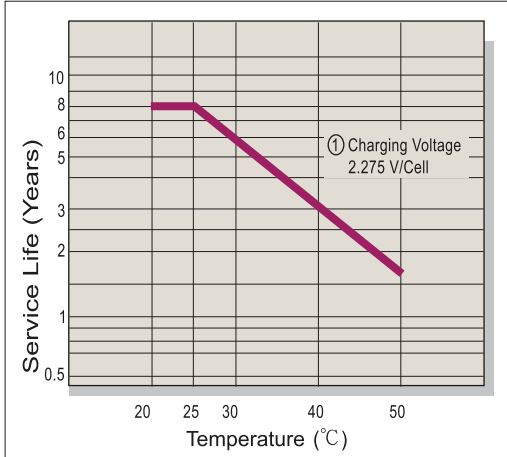

### Capacity Retention Characteristic

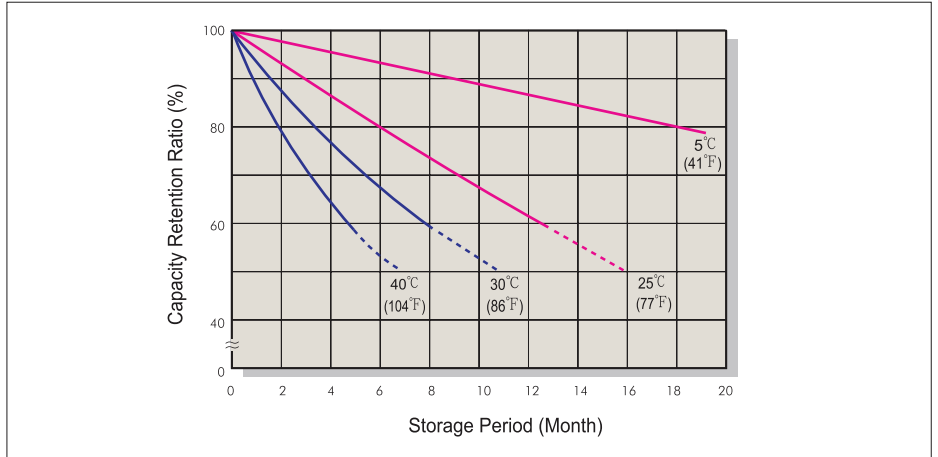

### Battery Voltage and Charge Time for Standby Use

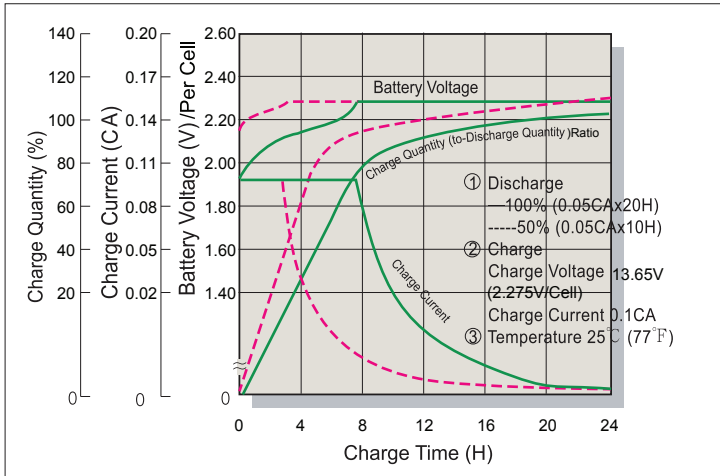

### Cycle Service Life

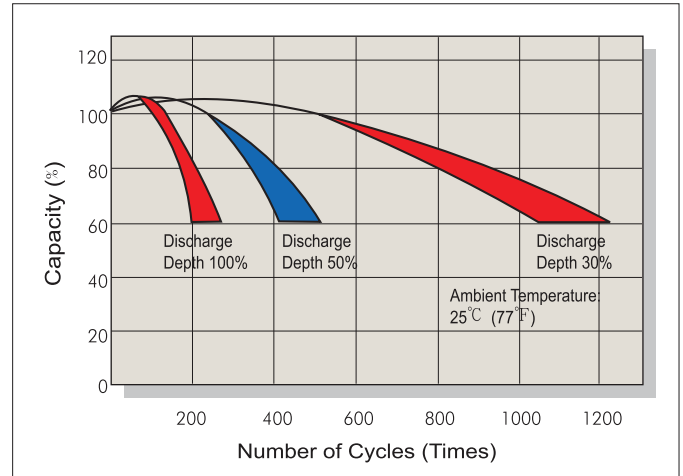

### Battery Voltage and Charge Time for Cycle Use

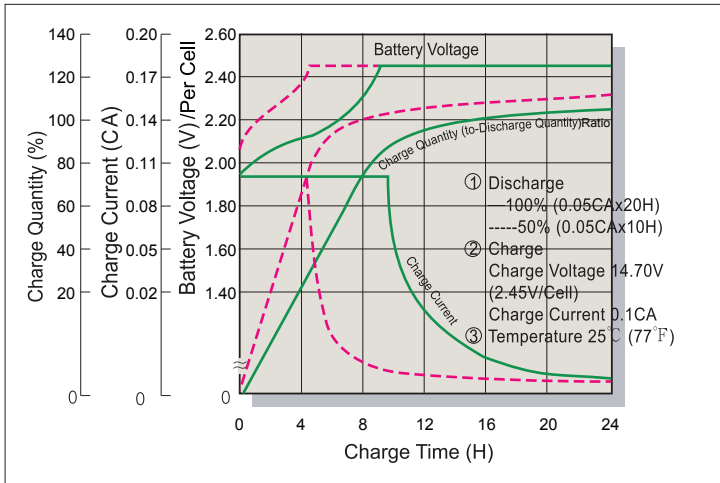

### Terminal Voltage (V) and Discharge Time

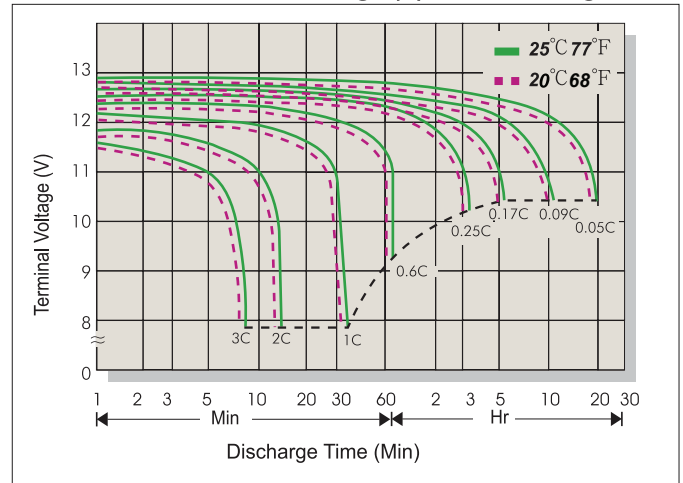

### Charging Procedures

Application	Charge Voltage(V/Cell)			Max.Charge Current
	Temperature	Set Point	Allowable Range	
Cycle Use	25°C(77°F)	2.45	2.40~2.50	0.3C
Standby	25°C(77°F)	2.275	2.25~2.30	

### Discharge Current VS. Discharge Voltage

Final Discharge Voltage V/Cell	1.75	1.70	1.60	1.30
Discharge Current(A)	0.2C>(A)	0.2C<(A)<0.5C	0.5C<(A)<1.0C	(A)>1.0C

Sales Office URL: [WWW.CSB-BATTERY.COM](http://WWW.CSB-BATTERY.COM)

**GLOBAL HQ**  
**CSB BATTERY CO., LTD. (TAIWAN)**  
 Tel : +886-2-2880-5600  
 Fax : +886-2-2888-3300  
 mail : service@csb-battery.com.tw

**BEIJING OFFICE. (CHINA)**  
**CSB BATTERY TECHNOLOGIES (BEIJING) CO., LTD.**  
 Tel : +86-10-5820-5336/5338  
 Fax : +86-10-58203053  
 mail : chinasl@csb-battery.com

**AMERICA HQ**  
**CSB BATTERY TECHNOLOGIES INC. (U.S.A)**  
 Tel : +1-817-244-7777/1-(800)3-CSB-USA(272872)  
 Fax : +1-817-244-4445  
 mail : csb@csb-battery.com

**SHANGHAI OFFICE. (CHINA)**  
**CSB BATTERY LOGISTIC (SHANGHAI) CO., LTD.**  
 Tel : +86-21-5046-1622/5046-0833  
 Fax : +86-21-5064-1046  
 mail : chinasl@csb-battery.com

**EUROPE HQ**  
**CSB Battery Europe BV.**  
 Tel : +31(0)-180-418-140  
 Fax : +31(0)-180-418-327  
 mail : eurosales@csb-battery.eu

**SHENZHEN OFFICE. (CHINA)**  
**CSB BATTERY LOGISTIC (SHANGHAI) CO., LTD.**  
 Tel : +86-755-8831-6488/6396/6356  
 Fax : +86-755-8831-6548  
 mail : she@csb-battery.com.cn